

## A Study on the Effect of Modified Feed-dogs on Satin Fabrics

Dr. Ghada Al-Gamal

Lecturer, Apparel Department, Faculty of Applied Arts, Helwan University, Cairo, Egypt

### Abstract:

Feed mechanisms is the basic component of the sewing machine, it is used to control the motion of the material being sewn. The improvement of the construction of the sewing machine feed mechanism aims to improve the quality of seams. This study aims to investigate the effect of using modified feed dogs, various levels of pressure for the presser foot and different number of studied fabric layers on the physical properties of slippery fabrics such as satin fabric. 7-end satin woven fabric has been used in three groups: two layers, three layers and four layers of fabric. Each group was sewed using different types of feed-dog: conventional teethed, toothless (trimmed teeth of feed-dog) and rubber coated feed-dog (flat gripper of rubber). Each specimen was sewed under three levels of pressure by the presser-foot: light press (one turn), normal press (thirteen turns) and heavy press (twenty-six turns). Three seamed lines were sewed along warp direction of the fabric with equal distance from each other. All specimens were subjected to the appearance and seam pucker test, a panel of ten experts (researchers and staff from the textile and clothing sectors) had evaluated the samples. On the basis of the study investigations carried out, it has been found that the use of rubber material covering the feed dog has a significant effect on the appearance and seam pucker of a satin fabric. Rubber-coated feed-dogs would feed even the finest of fabrics without snagging or leaving marks on the fabric. However, the pressure levels of the presser foot don't affect markedly the sewed fabric appearance and seam pucker. Finally, increasing the number of layers of satin fabric positively affects the fabric appearance and seam pucker.

### Keywords:

- Feed-dog,
- Slippery fabrics,]
- teeth pitch,
- feed mechanism
- teeth inclination

Paper received 25<sup>th</sup> of April 2015, Accepted 12<sup>th</sup> of May 2015 Published 1<sup>st</sup> of July 2015

### 1. Introduction

Feed mechanisms is the basic motion of needles, looper and bobbins, the material being sewn must move so that each cycle of needle motion involves a different part of the material. This motion is known as feed mechanism. (Ebrahimi S., 2014). There are a wide variety of sewing machine feeding mechanisms designed to handle the broad range of materials used in the industry (Sunil Talekar, 2014). The following are brief descriptions of the most common feed mechanisms. For general categories, there are: 1) Drop Feed: a type of feed which alternately engages and disengages the feed dog from the underside of the material as shown in figure (1) (Ahmadi, M. S., 2014).

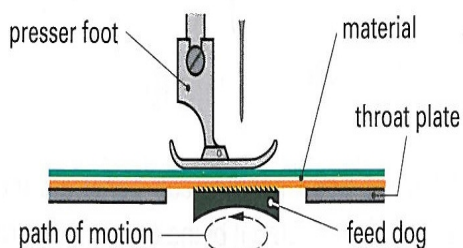

Figure (1): Drop feed mechanism

2) Differential Feed: a type of drop feed with two feed dogs arranged in tandem which move differentially. Machines with differential feed typically can be adjusted for gathering, stretching, or conventional drop feed sewing as shown in figure (2).

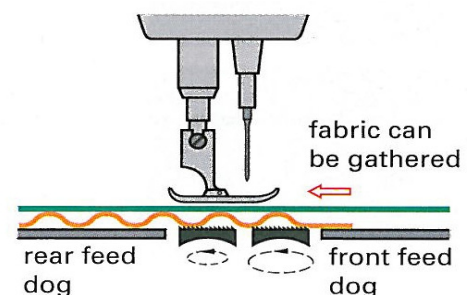
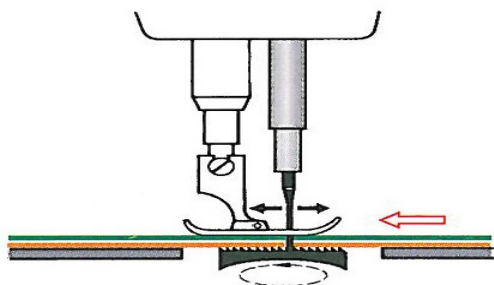

Figure (2): Differential feed mechanism

3) Needle Feed: a type of feed which has a "vibrating" or swinging needle bar that allows the needle to move the material ahead one stitch length. The needle enters an elongated hole in the needle plate after passing through the material (Vlastimil Votrubic & Pavel Šidlof, 2011). 4) Alternating Pressers or "Walking Foot": a type of

feed consisting of two presser feet, a feeding or "vibrating" presser (inside) and a lifting presser (outside). The presser feet work in combination and are arranged so that they press down alternately on the material. This makes the alternating pressers appear to "walk" over the fabric, and facilitates handling of materials with uneven thickness. 5) **Compound Needle Feed:** a type of feed with a vibrating (swinging) needle bar synchronized with a drop feed motion. In most cases, the needle hole is in the feed dog as shown in figure (3).



**Figure (3): Compound Needle feed mechanism**

6) **Unison Feed:** a type of feed consisting of a vibrating needle bar, alternating presser feet, and a bi-directional feed dog which comes flush to the surface of the needle plate. These three feed elements combine to provide optimal feeding of difficult materials as shown in figure (4).

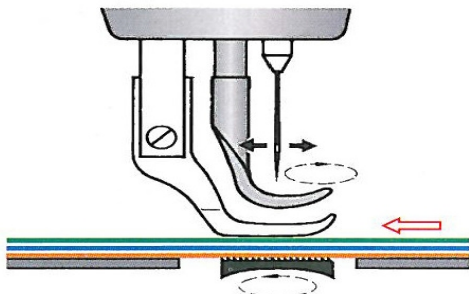

**Figure (4): Unison feed mechanism**

7) **Puller Feed:** a type of feed consisting of an independent mechanism with one or more rollers, which help feed the material from the machine. At least one of the rollers is driven continuously or intermittently as shown in figure (5).

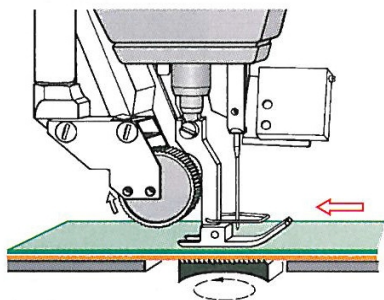

**Figure (5): Puller feed mechanism**

8) **Reversible Feed:** a type of feed where the direction of the drop feed can be reversed so the material feeds towards the operator instead of away. 9) **Upper Feed:** a type of feed where a positively driven feeding foot alternately engages and disengages the upper side of the material. 10) **Universal Upper Feed:** a type of feed like upper feed above, except that the direction of the feeding foot can be altered, so that directional feeding of the material is possible. 11) **Upper and Under Feed:** a type of feed consisting of alternating presser feet operating in unison with a drop feed. 12) **Independent Upper and Under Feed:** a type of feed which consists of a feeding foot operating in conjunction with a drop feed. The lengths of stroke are independently adjustable so that the upper or under side of the material may feed faster, slower or at the same time (synchronized) (Mark Rofini, 2014). 13) **Under Wheel Feed:** a type of feed where a wheel is constantly engaged with the underside of the material. The feed can be continuous or intermittent, and continuous wheel feed machines use needle feed as well. 14) **Upper Wheel Feed:** a type of feed where a wheel is constantly engaged with the upper side of the material. 15) **Upper and Under Wheel Feed:** a type of feed where two wheels are constantly engaged with both the under and upper sides of the material. The rate of rotation of the wheels may be synchronized or independently adjustable according to need. 16) **Cup Feed:** a type of feed used on machines where the needle operates in the horizontal direction. Feeding is accomplished either by passing the material between the edges of two rotating discs (sometimes cup shaped) or by passing the material between one disc and a presser surface (C.H. Holderby, 2013).

It worth mentioning that the most important part in feed mechanism is the feed dog. Feed dog is the basic component of a sewing machine. It is located underneath the "needle plate" or "throat plate". It is to control the motion of fabric. The needle plate is used to cover the feed dog and feed dog pushes fabric towards the needle. After that, stitching is done on the fabric. The structure of the face side of the feed dog is zigzag and it contains rows of teeth (Description and Basic Functions of Feed Dog of a Sewing machine, 2012).

There are many types of feed dog teeth: (1) **Angular feed dog teeth:** angular feed dog teeth are generally used. This configuration offers increased feed efficiency in the forward feed direction as shown in figure 6.

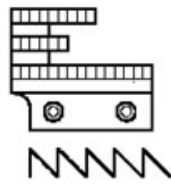

Figure (6): Angular feed dog teeth

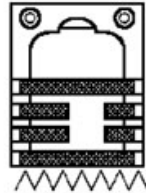

Figure (7): Zigzag feed dog teeth

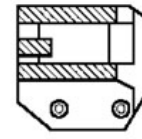

Figure (8): Diagonal feed dog teeth

(2) Zigzag feed dog teeth: this type of feed dog teeth excels in securing the material fabric in the crosswise direction. It is used for the top feed dog of zigzag stitching machines and bottom and variable top feed machines as shown in figure (7).

(3) Diagonal feed dog teeth: this type of feed dog teeth does not leave many marks on the material fabric. It is used for bottom and variable top feed machines (cloth puller) as shown in figure (8). (4) Urethane rubber feed dog teeth: this type of feed dog teeth is effective for sewing materials which are easily damaged by the other types of feed dogs. The urethane rubber feed dog teeth come in several different configurations, such as angular and flat; this type of feed dog is effective for sewing delicate materials such as georgette and glossy fabric (Ed Lamoureux, 2011).

Feed dog teeth configurations: (1) Pitch (distance between teeth): The feed dog teeth pitch varies from fine to coarse as shown in figure (9); the fine pitch (for light-weight material) lengthen 1.15 mm which the feed dog with fine-pitch teeth is suited for soft light-weight materials.

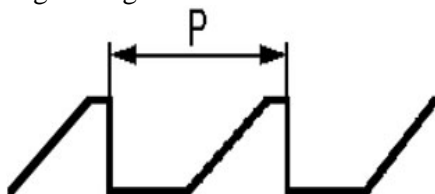
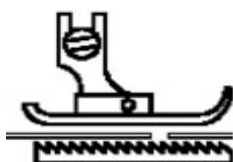

Figure (9): Feed-dog teeth feed pitch

If used with a heavy-weight material, the feed dog does not securely catch the material and does not provide adequate efficiency of feed, the standard pitch (medium-weight materials) lengthen 1.50 mm, the coarse pitch (for heavy-weight materials)

lengthen 1.80 mm which the feed dog with coarse-pitch teeth is suited for heavy-weight and slightly rigid sewing materials. If used with a light-weight material, puckering may result. Puckering is likely to occur since stitches are formed in the state where the material is caught in the gap between the feed dog teeth (Vaida Dobilaitė, Milda Jucienė, Eglė Mackevičienė, 2013). (2) Number of teeth (number of rows): a smaller number of teeth (number of rows) provides better sharp-curve feeding capabilities, while larger number of teeth provides better straight feeding capabilities, increased efficiency of feed and increased stability of the material fabric. (3) Height and inclination of the feed dog; the feed dog height can be adjusted in the range of 0.5 mm to 1.2 mm according to the sewing material. Standard heights of the feed dog are as follows: for light-weight materials -> 0.5 mm to 0.6 mm, for medium-weight materials -> 0.7 mm to 0.8 mm, for heavy-weight materials -> 0.9 mm to 1.2 mm. When the height of the feed dog is too high: Efficiency of feed is adequate, but puckering is likely to occur (Brad Raluca , Hăloiu Eugen, Brad Remus, 2014).

When the height of the feed dog is too low: Efficiency of feed is inadequate, but puckering is not likely to occur. (4) Inclination of the feed dog: (a) the feed dog should be positioned level, as standard, to the throat plate. The inclination of the feed dog, however, should be changed according to the efficiency of feed or sewing fabric properties as shown in figure (10) (Ed Lamoureux, 2011).



(a) Standard (level)



(b) Position of the feed dog with its side opposite the operator in a lowered position.

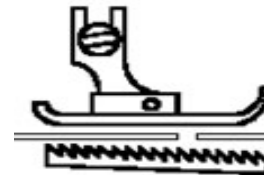

(c) Position of the feed dog with its side opposite the operator in a raised position.

Figure (10): Slope of feed dog

(b) The feed dog is positioned with its side opposite the operator in a lowered position: This position of the feed dog is suited for knits which are likely to cause uneven material feed or material slippage (Basic knowledge of the presser foot, feed dog and throat plate, 2014). But when the feed dog is positioned with its side opposite the operator in a raised position (c): This position of the feed dog is suited for sewing materials which are likely to suffer puckering (Cloth pulling effect).

As far as the different types of feed-dogs and feed mechanisms affects the process of sewing, also the type of fabric markedly determine the behave of sewing process. This is clearly obvious in slippery fabrics such as satin. Satin fabric is made from filament yarns, with the warp yarns predominant on the face. Satin fabrics are smooth and lustrous because lustrous filament yarns are used; there are few interlacing points, that give long floats; and the face yarns are fine and closely packed. Since the greatest lustre is in the lengthwise (warp) direction, garments using this fabric in warp direction show lustre effect (Jimmy Lam, 2010).

**Objectives**

This study aims to investigate the effect of using modified feed dogs, various levels of pressure for the presser foot and different number of studied fabric layers on the physical properties of slippery fabrics such as satin fabric.

**Methodology**

In this study, 7-end satin woven fabric weighted (190 gm/m<sup>2</sup>) has been used in three groups: two layers, three layers and four layers of fabric. Each group was sewed using different types of feed-dog: conventional teethed, toothless (trimmed teeth of feed-dog) and rubber coated feed-dog (flat gripper of rubber). Each specimen was sewed under three levels of pressure by the presser-foot: light press (one turn), normal press (thirteen turns) and heavy press (twenty-six turns). The size of each specimen was 380mm width and 390 mm height, three seamed lines were sewed along warp direction of the fabric with equal distance from each other. All specimens were subjected to the

appearance and seam pucker test, a panel of ten experts (researchers and staff from the textile and clothing sectors) had evaluated the samples. For the appearance test, the experts made an assessment using a 6-point scale. Six plastic replicas used to visually evaluate the appearance of specimens with values 1 to 6 (control sheets) were given to the experts and they were asked to evaluate the appearance of specimens, subjective evaluation is based on the AATCC/ISO Smoothness Appearance test Method G246K. For the seam pucker test, the experts made an assessment using a 5-point scale as shown in figure (11); subjective evaluation is based on the AATCC 88B seam pucker test Method (S. Hati and B.R. Das, 2011).

All tests were performed in standard atmospheric conditions (20±2°C temperature and 65±4% relative humidity).

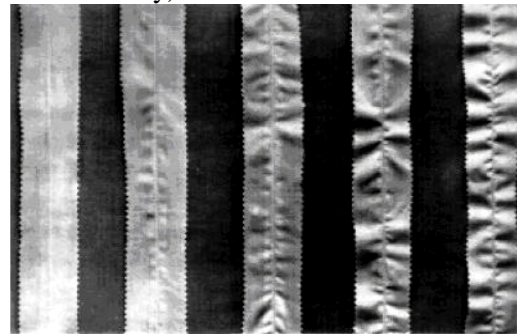

Figure (11): Reference seams for the seam inspection

**Results & Discussion**

Appearance and seam pucker tests were performed; results were documented and analyzed statistically according to descriptive analysis and correlation coefficient to show the effect of different variables on satin fabrics, table (1) lists the mean values and standard deviations of the appearance and seam pucker evaluations of 27 panelists. Since the subjective test results show normal distribution, test values were evaluated by using variance analysis method.

**Table (1): The mean values and standard deviation of the appearance and seam pucker tests**

Feed-Dog Type	Presser-Foot	No. of Layers	Code	Appearance				Seam Pucker			
				Mean (x)	Std. Dev.	Min.	Max.	Mean (x)	Std. Dev.	Min.	Max.
Rubber Coated	Light Press	2 layers	a32	3.443	0.407	2.638	4.247	5.000	0.357	4.284	5.716
		3 layers	a33	3.657	0.407	2.853	4.462	4.667	0.357	3.951	5.383
		4 layers	a34	3.029	0.407	2.224	3.833	4.667	0.357	3.951	5.383

	Normal Press	2 layers	a22	3.114	0.407	2.310	3.919	4.333	0.357	3.617	5.049	
		3 layers	a23	3.457	0.407	2.653	4.262	4.000	0.357	3.284	4.716	
		4 layers	a24	3.414	0.407	2.610	4.219	4.333	0.357	3.617	5.049	
		Heavy Press	2 layers	a12	4.314	0.407	3.510	5.119	4.667	0.357	3.951	5.383
			3 layers	a13	3.214	0.407	2.410	4.019	4.667	0.357	3.951	5.383
			4 layers	a14	2.229	0.407	1.424	3.033	1.333	0.357	0.617	2.049
	Toothless	Light Press	2 layers	b32	3.057	0.407	2.253	3.862	3.000	0.357	2.284	3.716
			3 layers	b33	3.400	0.407	2.596	4.204	3.000	0.357	2.284	3.716
			4 layers	b34	3.600	0.407	2.796	4.404	4.333	0.357	3.617	5.049
		Normal Press	2 layers	b22	2.071	0.407	1.267	2.876	2.000	0.357	1.284	2.716
			3 layers	b23	3.043	0.407	2.238	3.847	3.000	0.357	2.284	3.716
			4 layers	b24	3.214	0.407	2.410	4.019	4.000	0.357	3.284	4.716
Heavy Press		2 layers	b12	1.457	0.407	0.653	2.262	1.000	0.357	0.284	1.716	
		3 layers	b13	3.071	0.407	2.267	3.876	3.000	0.357	2.284	3.716	
		4 layers	b14	3.443	0.407	2.638	4.247	5.000	0.357	4.284	5.716	
Conventional Teethed		Light Press	2 layers	c32	1.986	0.407	1.181	2.790	2.000	0.357	1.284	2.716
			3 layers	c33	2.457	0.407	1.653	3.262	3.000	0.357	2.284	3.716
			4 layers	c34	2.357	0.407	1.553	3.162	4.000	0.357	3.284	4.716
	Normal Press	2 layers	c22	2.271	0.407	1.467	3.076	2.000	0.357	1.284	2.716	
		3 layers	c23	2.929	0.407	2.124	3.733	2.000	0.357	1.284	2.716	
		4 layers	c24	2.786	0.407	1.981	3.590	4.333	0.357	3.617	5.049	
	Heavy Press	2 layers	c12	1.986	0.407	1.181	2.790	4.333	0.357	3.617	5.049	
		3 layers	c13	2.657	0.407	1.853	3.462	5.000	0.357	4.284	5.716	
		4 layers	c14	3.171	0.407	2.367	3.976	5.000	0.357	4.284	5.716	

Results were expressed as the mean 00B1 standard deviation. The mean values of variables were compared using unpaired t-tests. IBM SPSS Statistics software version 16.0 (Chicago, Illinois, USA) was used for data analysis. A p-value less than or equal to 0.05 was considered statistically significant; a p-value less than or equal to 0.01 was considered statistically highly significant.

**Appearance test:**

**Effect of Feed-dog type on appearance test:**  
As shown in table (2) analysis of statistical results of the modified feed-dogs and the comparison between them revealed that all the results were considered statistically significant (p-value is less than 0.05) whilst comparing the mean value of the rubber coated feed-dog with the conventional feed-dog was considered statistically highly significant (p-value is equal 0.00).

**Table (2): Statistical comparison between modified feed-dogs for appearance test**

(I) Feed-dog	(J) Feed-dog	Mean Difference (I-J)	Std. Error	Sig.(a) (p-value)	95% Confidence Interval for Difference(a)	
		Lower Bound	Upper Bound	Lower Bound	Upper Bound	Lower Bound
Fa	Fb	.390(*)	.192	.044	.011	.770
	Fc	.808(*)	.192	.000	.429	1.187
Fb	Fa	-.390(*)	.192	.044	-.770	-.011
	Fc	.417(*)	.192	.031	.038	.797
Fc	Fa	-.808(*)	.192	.000	-1.187	-.429
	Fb	-.417(*)	.192	.031	-.797	-.038

Fa =rubber coated feed-dog, Fb =Toothless feed-dog, Fc =conventional teethed feed-dog

**Effect of pressure level on appearance test:** Table (3) illustrates analysis of statistical results of the pressure levels by the presser-foot and the comparison between them

revealed that all the results were considered statistically not significant (p-value is more than 0.05).

**Table (3): Statistical comparison between pressure levels for appearance test**

(I) Press	(J) Press	Mean Difference (I-J)	Std. Error	Sig.(a) (p-value)	95% Confidence Interval for Difference(a)	
		Lower Bound	Upper Bound	Lower Bound	Upper Bound	Lower Bound
Ph	Pl	-.160	.192	.405	-.540	.219
	Pm	-.084	.192	.662	-.463	.295
Pl	Ph	.160	.192	.405	-.219	.540
	Pm	.076	.192	.692	-.303	.455
Pm	Ph	.084	.192	.662	-.295	.463
	Pl	-.076	.192	.692	-.455	.303

Ph= heavy press, Pl=light press, Pm= normal press

**Table (4): Statistical comparison between numbers of layers for appearance test**

(I) Layers	(J) Layers	Mean Difference (I-J)	Std. Error	Sig.(a) (p-value)	95% Confidence Interval for Difference(a)	
		Lower Bound	Upper Bound	Lower Bound	Upper Bound	Lower Bound
L2	L3	-.465(*)	.192	.017	-.844	-.086
	L4	-.394(*)	.192	.042	-.773	-.014
L3	L2	.465(*)	.192	.017	.086	.844
	L4	.071	.192	.710	-.308	.451
L4	L2	.394(*)	.192	.042	.014	.773
	L3	-.071	.192	.710	-.451	.308

L2=2 layers, L3=3 layers, L4=4 layers

Figure (12) represents the results of the study tests that were carried on the specimens, it was observed that using rubber feed-dog with heavy press of presser foot in sewing two layers recorded the highest appearance, while using the toothless

feed-dog with heavy press of presser foot in sewing two layers recorded the lowest appearance.

**Seam Pucker Test:**

**Effect of Feed-dog type on seam pucker test:**

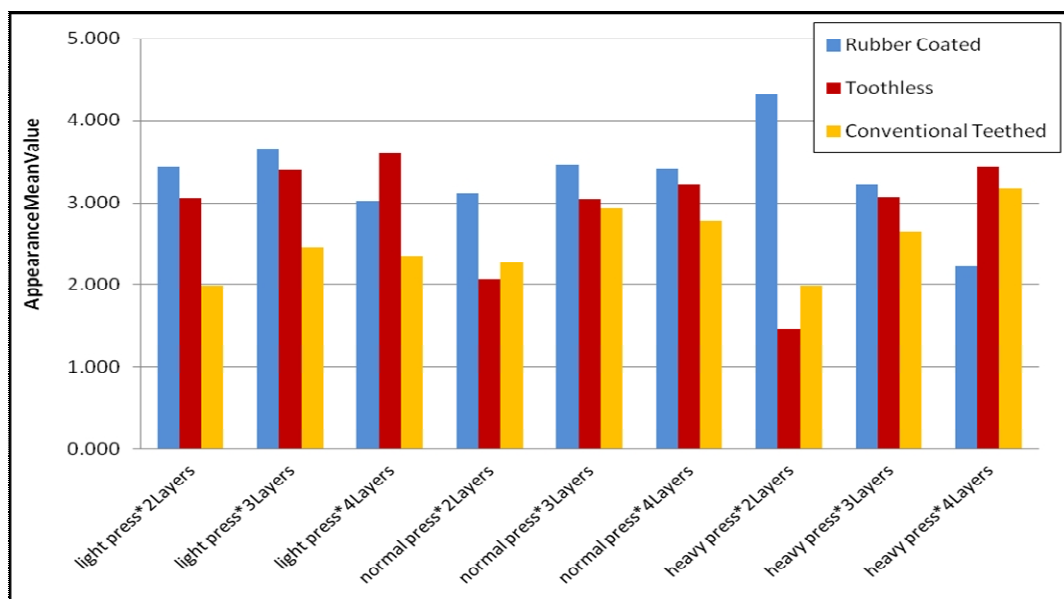

Figure (12): Effect of using modified feed-dogs on mean values of appearance test

Table (5) highlights the analysis of statistical results of the modified feed-dogs and the comparison between them; all the results were considered statistically highly significant (p-value is equal 0.00). However, comparing the mean value of the toothless feed-dog with the conventional feed-dog was considered statistically significant (p-value is less than 0.05).

**Effect of number of layers on appearance test:**

As shown in table (4) analysis of statistical results of number of fabric layers the comparison between them revealed that all the

results were considered statistically significant (p-value is less than 0.05) except comparing the mean value of using three layers with four layers was found statistically not significant.

As shown in table (4) analysis of statistical results of number of fabric layers the comparison between them revealed that all the results were considered statistically significant (p-value is less than 0.05) except comparing the mean value of using three layers with four layers was found statistically not significant.

**Table (5): Statistical comparison between modified feed-dogs for seam pucker test**

(I) Feed	(J) Feed	Mean Difference (I-J)	Std. Error	Sig.(a) (p-value)	95% Confidence Interval for Difference(a)	
		Lower Bound	Upper Bound	Lower Bound	Upper Bound	Lower Bound
Fa	Fb	1.037(*)	.168	.000	.699	1.375
	Fc	.667(*)	.168	.000	.329	1.004
Fb	Fa	-1.037(*)	.168	.000	-1.375	-.699
	Fc	-.370(*)	.168	.032	-.708	-.033
Fc	Fa	-.667(*)	.168	.000	-1.004	-.329
	Fb	.370(*)	.168	.032	.033	.708

Fa= rubber coated feed-dog, Fb= Toothless feed-dog, Fc= conventional teethed feed-dog

**Effect of pressure level on seam pucker test:**

As shown in table (6) analysis of statistical results of the levels of pressure by the presser-foot and the comparison between them revealed that all the results were considered statistically significant (p-

value is less than 0.05), while comparing the mean value of the heavy press with the light press of the presser foot was considered statistically not significant (p-value is 0.827).

**Table (6): Statistical comparison between pressure levels for seam pucker test**

(I) Press	(J) Press	Mean Difference (I-J)	Std. Error	Sig.(a) (p-value)	95% Confidence Interval for Difference(a)	
		Lower Bound	Upper Bound	Lower Bound	Upper Bound	Lower Bound
Ph	Pl	.037	.168	.827	-.301	.375
	Pm	.444(*)	.168	.011	.107	.782
Pl	Ph	-.037	.168	.827	-.375	.301
	Pm	.407(*)	.168	.019	.070	.745
Pm	Ph	-.444(*)	.168	.011	-.782	-.107
	Pl	-.407(*)	.168	.019	-.745	-.070

Ph= heavy press, Pl=light press, Pm= normal press

**Effect of number of layers on seam pucker test:**

As shown in table (7) analysis of statistical results of the number of fabric layers and the comparison

between them stated that all the results were statistically highly significant.

**Table (7): Statistical comparison between numbers of layers for seam pucker test**

(I) Layers	(J) Layers	Mean Difference (I-J)	Std. Error	Sig.(a) (p-value)	95% Confidence Interval for Difference(a)	
		Lower Bound	Upper Bound	Lower Bound	Upper Bound	Lower Bound
L2	L3	-.444(*)	.168	.011	-.782	-.107
	L4	-.963(*)	.168	.000	-1.301	-.625

L3	L2	.444(*)	.168	.011	.107	.782
	L4	-.519(*)	.168	.003	-.856	-.181
L4	L2	.963(*)	.168	.000	.625	1.301
	L3	.519(*)	.168	.003	.181	.856

L2=2 layers, L3=3 layers, L4=4 layers

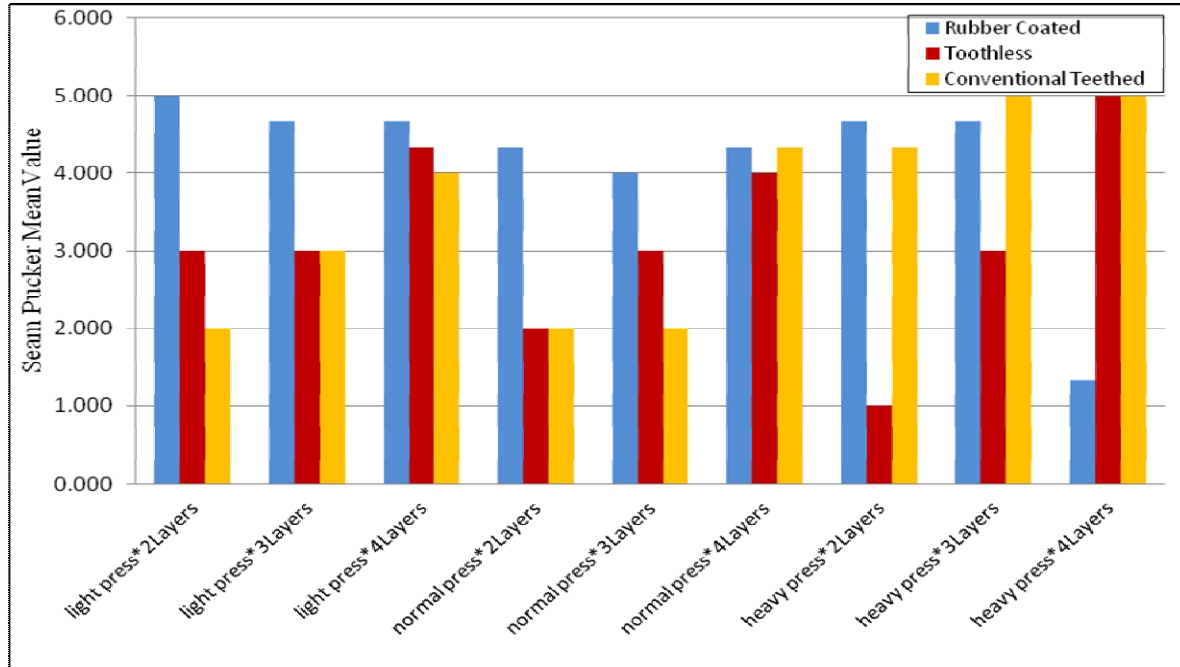

Figure (13): Effect of using modified feed-dogs on mean values of seam pucker test

As shown in figure (13) the results of the seam pucker test that were carried on the specimens, using rubber feed-dog with light press of presser foot in sewing two layers recorded the highest seam pucker value, whilst using the toothless feed-dog with heavy press of presser foot in sewing two layers recorded the lowest seam pucker value.

As regard the type of feed-dog, the study results showed that the rubber-coated feed-dog fulfilled the best appearance and seam pucker values of satin fabric; this is because a feed dog covered with supple material like rubber increase the coefficient of friction between the feed dog and the satin fabric. If the coefficient of friction between the feed dog and the fabric is higher, then the compressive force acting on the fabric can be considerably decreased, as a result the fabric is pressed to a lesser degree, and this improve the condition of movement of the fabric being sewn.

As regard the pressure level of the presser foot , the study results stated that there is no significant effect on the appearance values of satin fabric; this is because satin fabric features which are slippery and fine (L. F. Silva, M. Lima, C. Couto, J. Coelho, F. N. Ferreira, A. M. Rocha, 2000) .

As regard the number of layers of satin fabric, the study results highlighted that there is a direct relationship between increasing the number of sewed layers and either the appearance or the seam

pucker values. This is because whenever the number of sewed layers is increased the slipping between fabric layers is reduced.

**Conclusion**

On the basis of the study investigations carried out, it has been found that the use of rubber material covering the feed dog has a significant effect on the appearance and seam pucker of a satin fabric: the suppleness of the rubber material covering the feed dog enables us to avoid the use of the tooth-shaped coupling obtained by pressing the teeth into the fabric. Thus enhancing the appearance and seam pucker. Accordingly, rubber-coated feed-dogs are a good idea. They would feed even the finest of fabrics without snagging or leaving marks on the fabric. However, the pressure levels of the presser foot don't affect markedly the sewed fabric appearance and seam pucker. Finally, increasing the number of layers of satin fabric positively affects the fabric appearance and seam pucker.

**References**

- Ahmadi, M. S. (2014) "Feeding Systems" Textile Engineering Dept. Yazd University, available at [www.textile.yazd.ac.ir/ms.ahmadi/Downloads/Sewing%20Technology/SewingTechnology-P3.pdf](http://www.textile.yazd.ac.ir/ms.ahmadi/Downloads/Sewing%20Technology/SewingTechnology-P3.pdf)
- Basic knowledge of the presser foot, feed dog



- and throat plate (2014) available at [www.juki.co.jp/jm\\_int/magazine/vol/vol004/jm\\_v004p10.html](http://www.juki.co.jp/jm_int/magazine/vol/vol004/jm_v004p10.html)
- Brad Raluca , Hăloiu Eugen, Brad Remus (2014), “Seam Puckering Evaluation Method For Sewing Process”, Annals of the University of Oradea. Fascicle of Textiles, Leatherwork, Vol XV, Iss 1, Pp 23-28
  - C.H. Holderby (2013), “Industrial Sewing Machines: Feeding the Material” available at [www.chholderby.com/industrial-sewing-machines/feeding-the-material](http://www.chholderby.com/industrial-sewing-machines/feeding-the-material)
  - Description and Basic Functions of Feed Dog of a Sewing machine (2012) available at [www.textilefashionstudy.com/description-and-basic-functions-of-feed-dog-of-a-sewing-machine](http://www.textilefashionstudy.com/description-and-basic-functions-of-feed-dog-of-a-sewing-machine)
  - Ebrahimi S. (2014), “Multiobjective Constrained Optimization of a Newly Developed Needle Driving Mechanism in Sewing Machine for Performance Improvement”, Int J Advanced Design and Manufacturing Technology, Vol. 7/ No. 4/ December –
  - Ed Lamoureux (2011), “Who Let the Feed Dog Out?” available at [www.sewing-machines.blogspot.com/2011/07/who-let-feed-dogs-out.html](http://www.sewing-machines.blogspot.com/2011/07/who-let-feed-dogs-out.html)
  - Jimmy Lam (2010), “Woven Fabric Structure (2) Twill, Satin & Sateen”, Institute of Textiles & Clothing
  - L. F. Silva, M. Lima, C. Couto, J. Coelho, F. N. Ferreira, A. M. Rocha (2000), “Mechatronics Approach for a Controlled Actuation of the Presser Foot Mechanism on an Industrial Sewing Machine”, Acta Polytechnica : Journal of advanced engineering, Vol 40, No 4
  - ark Rofini (2014), “Sewing Machine Feed Systems” available at [www.industrialsew-machine.com/webdoc3/feed.htm](http://www.industrialsew-machine.com/webdoc3/feed.htm)
  - S. Hati and B.R. Das (2011), “**Seam Pucker in Apparels: A Critical Review of Evaluation Methods**”, Asian Journal of Textile, 1: 60-73
  - Sunil Talekar (2014), “Sewing Machine Feed Mechanism” available at [www.slideshare.net/suniltalekar1/feed-machanism?related=1](http://www.slideshare.net/suniltalekar1/feed-machanism?related=1)
  - Vaida Dobilaitė, Milda Jucienė, Eglė Mackevičienė (2013), “The Influence of Technological Parameters on Quality of Fabric Assemble”, Materials Science, Vol 19, Iss 4, Pp 428-432
  - Vlastimil Votrubec, Pavel Šidlof (2011), “Optimization Example Of Industrial Sewing Machines Mechanisms”, Modelica Conference, Dresden, Germany